

### CONTENTS

1. Product identification	2
2. Characteristics	2
3. Applications	2
4. Fabrication and finishing techniques	2
5. Statements and certificates	3
5.1. Food approval statement	3
5.2. Fire classification according to European and other standards	3
5.3. Noise protection	3
5.4. Quality management	3
5.5. Warranty	3
5.6. Product Safety statement	3
6. Technical information	4
6.1. Technical data sheet POLYCASA XT - POLYCASA XT 610 - XT 620 - XT 630	4
6.1. Chemical resistance	5
6.2. Product range POLYCASA XT	6
6.3. Special products	7
7. User guide	9
7.1. Introduction	9
7.2. Storing and handling	9
7.3. Material preparation	10
7.3.1. Cleaning	10
7.3.2. Drying	10
7.3.3. Thermal linear change	11
7.3.4. Dimensional change effected by moisture content	11
7.3.6 Flatness	12
7.4. Surface treatment	12
7.4.1. Printing	12
7.4.2. Laminating	12
7.5. Machining	13
7.5.1. General recommendations	13
7.5.2. Sawing	13
7.5.3. Drilling	14
7.5.4. Thread cutting	14
7.5.5. Milling	14
7.5.6. Laser cutting	15
7.5.7. Water jet cutting	15
7.5.8. Polishing	15
7.6. Jointing	16
7.6.1. Bonding	16
7.6.2. Welding	17
7.7. Forming	18
7.7.1. Hot bending	18
7.7.2. Thermoforming	18
7.7.3. Tempering	19
7.8. Glazing	20
7.8.1. Vertical and horizontal glazing	20
7.8.2. Barrel vaults	21
7.8.3. Thermal insulation	21
8.0 Concluding remarks	22

## POLYCASA XT - ACRYLIC SHEETS

### 1. PRODUCT IDENTIFICATION

---

POLYCASA XT is the brand name for extruded Polymethyl methacrylate (PMMA) sheets manufactured by POLYCASA.

The POLYCASA XT programme offers solutions to both indoor and outdoor applications.

POLYCASA XT is available in clear and opal white standard products and a wide range of colours and designs.

POLYCASA XT sheets are produced and tested according to DIN EN ISO 7823-2.

### 2. CHARACTERISTICS

---

POLYCASA XT sheets have good optical properties and a brilliant surface.

POLYCASA XT sheets offer excellent transparencies, good mechanical properties, are UV resistant, have very good weathering and ageing resistance and remain colour constant for years.

High impact grades, POLYCASA XT610, XT620, XT630, have outstanding mechanical properties and excellent impact strength.

Both POLYCASA XT sheets and all high impact grades can be used in contact with foodstuffs, as they meet all current European food control legislation.

POLYCASA XT sheets and the high impact grades do not contain any toxic materials or heavy metals, which may cause environmental damage or health risks. It is insoluble in water, and not subject to hazardous materials identification.

POLYCASA XT sheets and the high impact grades are easy to recycle.

### 3. APPLICATIONS

---

#### Construction components

- Light domes
- Partition walls
- Door glazing
- Roofing
- Skylights for caravans

#### Lighting

- Lighting control lenses
- Domestic light fittings

#### Engineering components

- Machine housings
- Machine safety covers

#### Advertising and signage

- Moulded letters
- Store Displays
- Shop fittings
- Illuminated graphics panels

#### Other applications

- Containers
- Lettering templates
- Solariums (special grade, UV-transmitting)
- Sound barrier walls

### 4. FABRICATION AND FINISHING TECHNIQUES

---

POLYCASA XT sheets are easy to handle.

They can be machined using all the usual methods, such as sawing, drilling, polishing etc., and are easy to thermoform.

More detailed information on these items can be found in our 'USER GUIDE', further in this brochure.

## POLYCASA XT - ACRYLIC SHEETS

### 5. STATEMENTS AND CERTIFICATES

---

#### 5.1. FOOD APPROVAL STATEMENT

---

POLYCASA XT and POLYCASA XT High Impact sheets can be used in contact with food.

POLYCASA XT and POLYCASA XT High Impact clear sheets are extruded from a high quality raw material Polymethyl methacrylate which meets the compositional requirements of EU directive 10/2011 relating to plastic materials and articles which come into contact with foodstuffs.

A detailed certificate of conformance is available from our customer service department.

#### 5.2. FIRE CLASSIFICATION ACCORDING TO EUROPEAN AND OTHER STANDARDS

---

- |  |  |   |
|--|--|---|
| <ul style="list-style-type: none"> <li>■ Europe</li> </ul> | <ul style="list-style-type: none"> <li>EN 13501-1 (formerly DIN 4102-1)</li> </ul> | <ul style="list-style-type: none"> <li>Euro class E (formerly Germany B2, France M4)</li> </ul> |
|--|--|---|
  
- |   |  |   |
|---|--|---|
| <ul style="list-style-type: none"> <li>■ Underwriters Laboratories</li> </ul> | <ul style="list-style-type: none"> <li>UL94</li> </ul> | <ul style="list-style-type: none"> <li>UL94 HB</li> </ul> |
|---|--|---|

#### 5.3. NOISE PROTECTION

---

POLYCASA XT sound barrier walls and its variations have been tested and approved according to the European standards EN 1793 and EN 1794 and correspond to the German regulatory ZTV-Lsw06.

They comply with the requirements: noise insulation, fire performance, stability under wind load and stone cast resistance.

Certificates are available from our customer service department.

#### 5.4. QUALITY MANAGEMENT

---

POLYCASA XT and POLYCASA XT High Impact sheets are manufactured and audited for quality in compliance with the certified and regularly audited production and quality management system according to EN ISO 9001:2008.

#### 5.5. WARRANTY

---

POLYCASA XT and POLYCASA XT High Impact sheets are suitable for outdoor use.

POLYCASA provides a 10-year warranty for flat transparent sheets for minimum light transmission and mechanical properties. The warranty shall come into force the day the POLYCASA XT and POLYCASA XT high impact sheets are delivered to the customer.

The warranty applies exclusively to standard POLYCASA XT and POLYCASA XT high impact sheets used correctly as flat sheets which are installed, handled, machined, fabricated and maintained according to POLYCASA PLASTICS' recommendations and instructions.

No warranty will be available for sheets that have been exposed to corrosive materials and environments.

Detailed warranty terms and conditions in accordance to CISG (United Nations Convention on Contracts for the International sale of Goods) are available from our customer service department.

#### 5.6. PRODUCT SAFETY STATEMENT

---

Product handling information documents for POLYCASA XT and POLYCASA XT high impact products are available upon request.

## POLYCASA XT - ACRYLIC SHEETS

### 6. TECHNICAL DATA

#### 6.1. Technical data sheet POLYCASA XT - POLYCASA XT 610 - XT 620 - XT 630

<b>GENERAL</b>						
Property	Method	Units	POLYCASA XT	POLYCASA XT 630	POLYCASA XT 620	POLYCASA XT 610
Density	ISO 1183	g/cm <sup>3</sup>	1.19	1.17	1.16	1.15
Water absorption 24h/23°C – 50x50x4mm <sup>3</sup>	DIN EN ISO 62 Method 1	%	0.2	0.25	0.3	0.3
Ball indentation hardness	ISO 2039-1	MPa	235	155	135	100
Forming temperature air pressure		°C	140-160	130-150	130-150	130-150
Forming temperature vacuum		°C	160-190	140-170	140-170	140-170
Moulding shrinkage		%	0.5-0.8	0.6-0.9	0.6-0.9	0.6-0.9
<b>MECHANICAL</b>						
Property	Method	Units	POLYCASA XT	POLYCASA XT 630	POLYCASA XT 620	POLYCASA XT 610
Tensile strength	ISO 527-2	MPa	70	55	50	40
Elongation at break	ISO 527-2	%	4	15	25	35
Tensile modulus	ISO 527-2	MPa	3200	2400	2100	1800
Flexural strength	ISO 178	MPa	115	90	85	65
Flexural modulus	ISO 178	MPa	3300	2400	2100	1800
Impact strength Charpy unnotched	ISO 179-1	kJ/m <sup>2</sup>	17	25	35	60
Impact strength Charpy notched	ISO 179-1	kJ/m <sup>2</sup>	2	3	4	5
<b>THERMAL</b>						
Property	Method	Units	POLYCASA XT	POLYCASA XT 630	POLYCASA XT 620	POLYCASA XT 610
Vicat temperature (B 50)*	ISO 306	°C	105	104	102	98
Specific heat capacity	ISO 11357-4	J/gK	1.47	1.5	1.5	1.5
Linear thermal expansion	DIN 53752	K <sup>-1</sup> *x10 <sup>-5</sup>	7	9	10	11
Thermal conductivity	DIN 52612	W/mK	0.18	0.18	0.18	0.18
Service temperature continuous use		°C	70	65	65	65
Max. temperature short term use		°C	90	85	80	75
Degradation temperature		°C	>280	>280	>280	>280
<b>OPTICAL</b>						
Property	Method	Units	POLYCASA XT	POLYCASA XT 630	POLYCASA XT 620	POLYCASA XT 610
Light transmission (3mm)	DIN 5036-3 / EN ISO 13468-2	%	92	91	91	90
Refractive index	ISO 489	n <sub>D</sub> <sup>20</sup>	1.492	1.492	1.492	1.492
<b>ELECTRICAL</b>						
Property	Method	Units	POLYCASA XT	POLYCASA XT 630	POLYCASA XT 620	POLYCASA XT 610
Surface resistivity	IEC 60093	Ω	3x10 <sup>15</sup> - 3x10 <sup>16</sup>	-	-	-
Volume resistivity	IEC 60093	Ω x m	1x10 <sup>13</sup> - 5x10 <sup>13</sup>	-	-	-
Electrical strength	IEC 60243-1	kV/mm	10	-	-	-
Dielectric strength	IEC 60243-1	kV/mm	30	30	30	30
Dielectrical dissipation factor 50 Hz	DIN 53483-2		0.06	-	-	-
Dielectrical dissipation factor 1 KHz	DIN 53483-2		0.04	-	-	-
Dielectrical dissipation factor 1 MHz	DIN 53483-2		0.02	0.03	0.03	0.03
Relative permittivity 50 Hz	DIN 53483-2		2.7	-	-	-
Relative permittivity 1 KHz	DIN 53483-2		3.1	-	-	-
Relative permittivity 1MHz	DIN 53483-2		2.7	2.9	2.9	2.9

\*Pre treatment 16h at 80°C

**Note:** These technical data of our products are typical ones; the actually measured values are subject to production variations

## POLYCASA XT - ACRYLIC SHEETS

### 6.2 Chemical resistance

At room temperature POLYCASA XT and POLYCASA XT high impact sheets are resistant to saturated hydrocarbons, aromatic free carburettor fuel and mineral oils, vegetable and animal fats and oils, water, aqueous salt solutions, diluted acids and alkalis.

Aromatic hydrocarbons and hydrogen chlorides, ester, ether and ketones attack POLYCASA XT and high impact POLYCASA XT.

#### Chemical resistance at 20°C

Acetone	-	Ethyl acetate	-	Acidity of wine	+
Ammonia	+	Glycerine	+	Xylene	-
Amyl alcohol	-	Fuel oil	o	Paraffin	+
Benzene, free from aromatics	+	Hexane	+	Petroleum ether	+
Benzole	-	Isopropanol	o	Phosphoric acid 10%	+
Boric acid	+	Coffee	+	Sulphuric acid 10%	+
Butanol	-	Caustic potash solution	+	Nitric acid 10%	+
Chlorinated hydro-carbon	-	Ketone	-	Hydrochloric acid 10%	+
Chloroform	-	Methylene chloride	-	Hydrochloric acid conc. 35%	+
Chlorinated water/air	o	Lactic acid 10%	+	Sodium carbonate	+
Dibutyl phthalate	-	Mineral oil	+	Salad vinegar	+
Diocyl phthalate	-	Caustic soda	+	Stearic acid	+
Glacial acetic acid	-	Nitrocellulose lacquer	-	Tea	+
Acetic essence	-	Oxalic acid	+	Turpentine	+
Aqueous acetic acid	+	Wax	+	Toluene	-
Ethanol	o	Hydrogen peroxide	o	Diluting agent	-

- + Resistant
- o Limited resistance
- Not resistant

## POLYCASA XT - ACRYLIC SHEETS

### 6.3 Product range POLYCASA XT

POLYCASA XT sheets are protected on both sides by laminated PE-film, except POLYCASA XT patterned sheets, which are only laminated on the smooth side.

#### ■ POLYCASA XT thickness range

From 1.5 mm up to 25 mm

Standard thicknesses of flat, clear sheets: 1.5 - 2 - 3 - 4 - 5 - 6 - 8 - 10 - 12 - 15 - 20 - 25 mm

#### ■ POLYCASA XT widths cut-on-line

Max. 2000 mm for 1.5 mm

Max. 2050 mm from 2.0 mm up to 25 mm

#### ■ POLYCASA XT length cut-on-line

Minimum length 1000/1250 mm (depending on the extrusion line)

Standard length 3050 mm

Over-lengths available upon request

#### ■ POLYCASA XT thickness tolerances

1.5 mm up to ≤3mm ± 10%

>3 mm up to 25 mm ± 5%

#### ■ POLYCASA XT cut-on-line tolerances

More than 1000 mm - 0 / + 0.3% (3 mm per 1000 mm)

#### ■ POLYCASA XT cut-to-size tolerances

For length and width

Till 1000 mm -0 / + 1.0 mm

From 1001 to 1500 mm -0 / + 1.5 mm

From 1501 to 2000 mm -0 / + 2 mm

#### ■ POLYCASA XT minimum production order for

Special thickness 3.000 kg/10.000kg (depending on the extrusion line)

Special pattern 3.000 kg

Custom made colour 5.000/10.000 kg (depending on the extrusion line)

Other thicknesses, sizes and tolerances are available upon request.

For a detailed overview of our product range ask for our Product selector brochure.

## POLYCASA XT - ACRYLIC SHEETS

### 6.4 Special products

#### **POLYCASA XT Sound Wall Barrier (SWB) 15 mm – 20 mm**

POLYCASA XT SWB is a sound absorbing material used in noise protection equipment on roads. It is transparent and allows an unhindered view of the surroundings.

POLYCASA XT sound wall barriers surpass the required minimum sound insulation factor (according to ZTV-Lsw 06 and EN 1793). Further characteristics of POLYCASA XT SWB are mechanical stability, weathering resistance and fire stability.

The relevant test certificates according to EN 1793/EN 1794 and an evaluation according ZTV-Lsw 06 can be obtained from our customer service upon request.

POLYCASA XT SWB is masked with a special protection film. Detailed information can be taken from the technical data sheet for POLYCASA XT SWB and can be obtained from our customer service upon request.

#### **POLYCASA XT UVT**

POLYCASA XT UVT is perfectly suitable for solariums and sun beds.

POLYCASA XT UVT has high transmittance in the UVA/UVB spectral range and very good resistance to degradation following exposure to these rays.

Further technical information and relevant warranties can be obtained from the technical service department upon request.

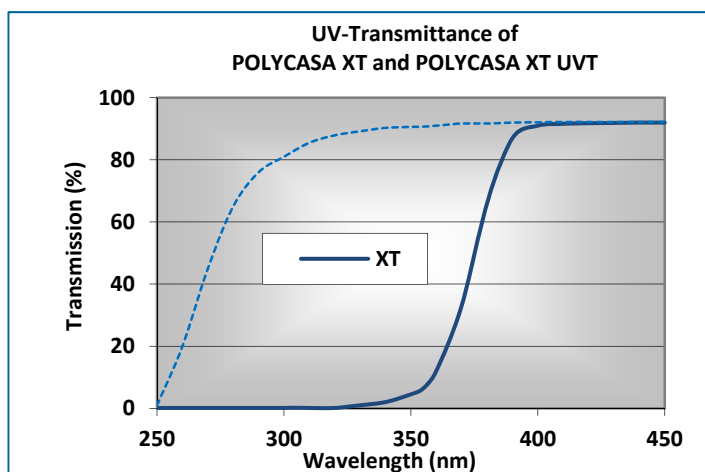

#### **POLYCASA XT soft tone**

POLYCASA XT soft tone combines the same mechanical properties of class leading POLYCASA XT clear sheet, but with the additional benefits of a double side matt finish, providing a stylish, trendy look without distracting reflections and an easy to maintain surface.

Technical data sheet are available from the customer service department.

POLYCASA XT soft tone is masked with a special protection film. Detailed information can be taken from the technical data sheet for POLYCASA XT soft tone and can be obtained from our customer service upon request.

## POLYCASA XT - ACRYLIC SHEETS

### **POLYCASA XT SBW soft tone**

POLYCASA XT SBW soft tone is a variation of the POLYCASA XT sound barrier wall grade with double-side mat finishes. (*Single-sided or coloured sheets on request*). The matt finished glazing being achieved by a special type of co-extruded lamination applied on both sides of the sheets. Owing to its outstanding properties, POLYCASA XT SBW soft tone offers a wide range of creative possibilities for building and industrial glazing where noise reduction is required.

POLYCASA XT Sound barrier walls systems equipped with POLYCASA XT SBW soft tone sheets are perfectly appropriate for reducing noise pollution.

Compared to standard POLYCASA XT Sound barrier walls, POLYCASA XT SBW soft tone is perfectly appropriate for applications where reflective effects have to be avoided. The matt finished characteristics are additionally suitable to increase the light scatter. The mechanical properties still cope with the well-known quality of POLYCASA XT Sound barrier wall grade.

### **POLYCASA XT SBW Flysafe**

Due to the excellent transparency of POLYCASA XT sound barrier wall sheets, approaching birds will not spot the sound barrier walls made of these sheets as an obstacle. Therefore POLYCASA XT SBW Flysafe was included in our product range.

Sound barrier wall systems equipped with POLYCASA XT SBW Flysafe sheets are perfectly suitable for reducing noise disturbance yet scare off approaching birds through special markings of a one-sided laminated foil. The foil still allows good transparency for the human eye but the markings appear as an obstacle for birds.

POLYCASA XT SBW Flysafe sheets qualify perfectly for applications where noise reduction and transparency are required plus at the same time protection against bird strike is provided.





## POLYCASA XT - ACRYLIC SHEETS

### 7 USER GUIDE

---

#### 7.1 INTRODUCTION

---

The manufacture of plastic articles from POLYCASA XT sheet normally involves secondary fabrication operations, including sawing, drilling, bending, decorating, and assembling.

This guide covers the properties and characteristics of POLYCASA XT that need to be taken into account if secondary operations are to be performed successfully.

#### 7.2 STORING AND HANDLING

---

The originally packed plastic sheets should neither be stored outside nor be exposed to great variations of weather and/or temperature. When storing under conditions with substantial variation of temperature and humidity, flat shape distortion (corrugation) of the sheet can happen, even when stored flat and stacked.

Polyethylene film protects sheets against dirt, mechanical load and scratches. It is recommended to leave the protective PE film in place until final processing.

Our standard PE protective film (without glue) is not designed for long-term open-air exposure/protection - it has only moderate UV- and heat-resistance.

If sheet is stored outside, without protection, the protective foil should be removed four weeks after film application latest, as there is a risk of brittleness and difficult removal of the degraded PE film. This could lead to the damage of the sheet surface.

If sheet is stored inside under normal stable storage conditions, it is recommended to remove the film 6 months after film application latest.

The special products POLYCASA XT SBW, POLYCASA XT SBW Soft tone and POLYCASA XT soft tone are masked with special films. Details regarding suitability and processing properties can be taken from the referring technical data sheets, which can be obtained from technical customer service.

POLYCASA XT standard products could be protected with self-adhesive foil on demand. It has to be considered that there is always a risk that the film could be difficult to remove and leave glue residues on the sheet surface after removal depending on storage conditions. POLYCASA is unable to give a recommendation in how long time the sheet can be safely stored with self-adhesive film. Customers are recommended to carry out their own trials. POLYCASA cannot take any responsibility for problems caused by self-adhesive film.

Depending on storage and climatic conditions, plastic sheets absorb moisture. Although humidity absorption has no practical influence on the physical properties, it may interfere during further processing of the sheets at higher temperatures e.g. during bending, or heating before thermoforming. Therefore, according to the intended use, the sheets may have to be pre-dried (see 7.3.2. Drying).

Differences in temperature and moisture-content between top- and bottom-side of sheet or between different sheet areas can cause different dimension changes inside the sheet. This can result in waviness of the sheet after a short time. It is recommended to store the sheet under constant temperature- and humidity-conditions on a flat surface.

## POLYCASA XT - ACRYLIC SHEETS

### 7.3 MATERIAL PREPARATION

---

#### 7.3.1 CLEANING

---

Protection film removal will induce a build-up of the electrostatic charge on the sheet surface. This electrostatic charge attracts airborne dust, and other fine particles. Therefore, prior to further processing, it is recommended to clean the sheet by antistatic treatment (e.g. blowing by ionised compressed air or cleaning by hand with a cloth wetted with suitable antistatic agents). This is particularly important prior to thermoforming process, as dust or dirt particles will cause imprints on the moulded surface. Plain water will suffice for both cleaning and care of the sheets.

In case of excessive dirt, clean with warm water and a weakly alkaline, non-abrasive cleaning agent.

The sheets should be dried with a soft cloth or with chamois leather.

Dry scrubbing of the surface will cause scratches and possible damage.

Very greasy and oily surfaces should be cleansed with aromatic -free benzine or petroleum ether.

Other chemicals suitable for cleaning POLYCASA XT sheets:

- Diluted acids such as citric acid, hydrochloric acid, sulphuric acid
- Diluted caustic soda or caustic potash solution
- Common vinegar
- White spirit, neutral soap and household detergents.

#### 7.3.2 DRYING

---

As with most plastics, POLYCASA XT sheets absorb moisture during storage.

Whilst processing at higher temperatures, this can produce bubbles; therefore, pre-drying below softening point temperature is advisable. Normally pre-drying of sheets with high moisture contents in an oven with air circulation, 24 hours at 80°C for POLYCASA XT and 24 hours at 75°C for POLYCASA XT high impact, will suffice.

To achieve good drying results, air circulation between the sheets must be ensured; the protection foil must be removed before drying.

POLYCASA XT sheet must be cooled down slowly to avoid repeated induction of moisture or internal stress due to cooling down too fast after drying. The maximum cooling speed after drying has to be less than 15°C per hour; the maximum oven temperature from which the sheet may be removed is 60°C.

Preliminary tests are recommended.

In general, POLYCASA XT sheets need not be pre-dried prior to thermoforming, provided that the material has been adequately stored and the foil is undamaged.

To minimise costs, the drying heat should be exploited by immediate follow-on forming after the drying process.

## POLYCASA XT - ACRYLIC SHEETS

### 7.3.3 DIMENSIONAL CHANGE

There are substantial orientation forces involved in the extrusion process to form the sheet from the molten polymer. A part of these forces remains "frozen" in the sheet.

When the sheet is to be heated e.g. before thermoforming, this stress became apparent in shrinkage of the sheet. The shrinkage is always higher in parallel to the extrusion direction. Longitudinal shrinkage is always higher in thin sheets and lower in thick sheets. Such dimensional change has to be taken into consideration when cutting sheets to be thermoformed.

When the material is heated and fixed in a clamping frame, no material shrinkage will arise.

As the shrinkage value depends on both heating temperature and heating time, preliminary tests are advisable.

Maximum longitudinal shrinkage values of POLYCASA XT safely comply with ISO 7823-2:

Sheet Thickness	Amount of shrinkage
1.50 mm up to <2 mm	≤15%
2.00 mm up to <3 mm	≤12%
3.00 mm up to 25 mm	≤7%

### 7.3.4 THERMAL LINEAR CHANGE

Like nearly all materials, POLYCASA XT is subject to linear change at variable temperatures. Plastics show higher linear change than metals, and this must be taken into account when mounting POLYCASA XT sheets into frames.

Material	$\alpha$ [mm/m•K]
POLYCASA XT	0,07
POLYCASA XT 630	0,09
POLYCASA XT 620	0,10
POLYCASA XT 610	0,11

**POLYCASA XT shows a coefficient of linear thermal expansion of 0.07 mm/m •°C.**

When mounting POLYCASA XT sheets, attention must be paid to the elongation clearance in order to avoid damage during material usage. For more technical data - see chapter „7.8 Glazing“.

### 7.3.5 DIMENSIONAL CHANGE EFFECTED BY MOISTURE CONTENT

POLYCASA XT absorbs moisture during storage and application. Beyond the thermal linear change, the content of moisture can effect an additional dimensional change up to 0.5%. When mounting POLYCASA XT sheets, attention must be paid to the elongation clearance in order to avoid damage during material usage.

Variation and differences in moisture content between interior and outside surface of a sheet (e.g. swimming-pool glazing, terrarium, greenhouse, winter garden) effect different elongation between the sheet surfaces. This difference can cause curvature of the mounted sheet. This curvature can be avoided by choosing an applicable higher thickness of sheet, in order to get inherent stability. Preliminary tests are recommended.

## POLYCASA XT - ACRYLIC SHEETS

### 7.3.6 FLATNESS

With increasing thickness extruded POLYCASA XT sheets can show a slight deviation in flatness due to the cooling behaviour of the material.

Flatness is determined on a cut-to-size sample 1000 x 1000 mm.

Thickness	Planarity
≤ 10 mm	≤ 2mm
> 10 mm	≤ 3 mm

## 7.4 SURFACE TREATMENT

### 7.4.1 PRINTING

Silk-screen printing is the most commonly used method for printing POLYCASA XT and allows the creation of a wide range of graphics.

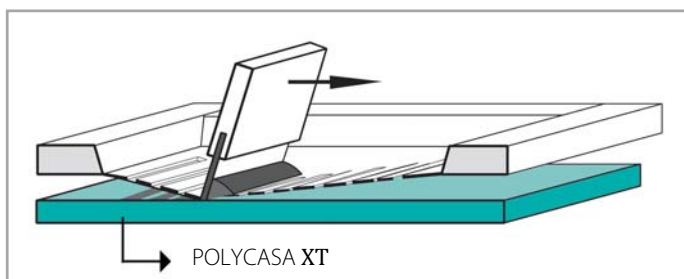

Distortion screen printing allows the flat sheet to be formed after printing into a three dimensional article with correct print register. Allowance must be made for “stretching” of the image when designing the graphics.

Halogen spotlight systems should not be used when thermoforming printed sheets.

During the silk-screen print process, the high-viscous ink is pushed through a photo chemically pre-treated screen print fabric (polyamide or polyester) by mechanical action or by means of a hand-operated scraper. The ink is transferred to the sheet beneath the screen fabric.

In order to avoid stress cracking of POLYCASA XT, only acrylic compatible inks must be used. The lacquer systems must be suitable for the intended application. Where necessary the sheet has to be tempered, pre-dried or cleaned before application of ink, to avoid stress cracks and adhesion problems. Preliminary tests are recommended.

Addresses of appropriate ink suppliers can be obtained from the Technical Service Department upon request.

Spray painting is another popular method for decorating sheet after moulding. Only ink or paints suitable for use with acrylic sheets should be used.

### 7.4.2 LAMINATING

The application of decorating foils or self-adhesive lettering or transfers is only suitable for flat or slightly curved sheets. Care should be taken that adhesive foils are used which not produce stress cracking of POLYCASA XT sheets.

Evaporation may cause partial separation of the self-adhesive film; therefore POLYCASA XT sheets should be pre-dried overnight at a temperature of 70 - 80°C. Impurities such as dust particles can also lead to partial foil removal, which will impair the appearance of the lamination. Where necessary the sheet has to be tempered or cleaned before application of ink, to avoid stress cracks and adhesion problems. Preliminary tests are recommended.

Addresses of appropriate adhesive foil suppliers can be obtained from the Technical Service Department upon request.

## POLYCASA XT - ACRYLIC SHEETS

### 7.5 MACHINING

#### 7.5.1 GENERAL RECOMMENDATIONS

POLYCASA XT sheets can be worked with most tools used for metals. Both cutting speed and forward feed should be such that the material doesn't melt.

The lowest possible heat development during cutting operations will avoid the need for material lubrication.

Sharp cutting tooling with cutting clearances suitable for POLYCASA XT are prerequisite.

Moreover, tool cooling, which should exclusively be done by water or acrylic compatible cooling emulsions, may eliminate heat. Cooling reduces local heating of the surface in process and the resultant post-processing strains and stresses.

#### 7.5.2 SAWING

Circular saws, band saws and jig saws can easily be used to work POLYCASA XT. The use of new and well sharpened tools is recommended. When using circular saws, blades with tungsten carbide-tipped cutting edges have proven effective. At very high cutting speeds and cut-off frequency respectively, the saw blade should be cooled by compressed air, water spray or using an adequate cooling emulsion.

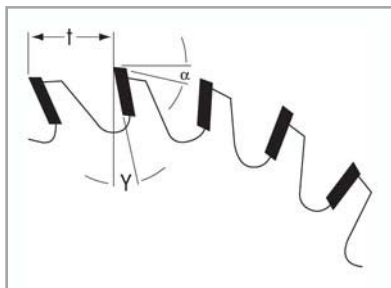

It is very important to employ an efficient saw dust extraction system to remove saw dust and chips generated by the saw blade.

Band saws are frequently used to trim the mouldings. The cut edge remains quite "rough" due to the slightly "crossed" saw teeth.

Jigsaws can cut out recess clearances. The cut edge often turns out to be rough. Only saw blades should be used which are suitable for acrylic treatment. When working with jigsaws, the shoe of the jigsaw must be tightly pressed to the surface of the sheet

and a high cutting speed should be selected. The rotary stroke should be switched off, especially when using thin sheets. The sheets must be adequately fixed to avoid saw chattering or vibrating.

**Table 1**  
**Sawing recommendations**

Band saw/circular saw machining	Band saw	Circular saw	Jigsaw
Clearance angle $\alpha$	30-40°	15-20°	Commercially available saw blades suitable for acrylic
Rake angle $\gamma$	0-8°	0-5°	
Cutting speed	1000-3000 m/min.	3000 m/min.	
Circular pitch t	3-8 mm	10-20 mm	

## POLYCASA XT - ACRYLIC SHEETS

### 7.5.3 DRILLING

Commercial quality twist drills for metal can be used. The point angle should be adapted to about 60°-90°. Best drilling capacity is achieved with a cutting speed of 25-80 m/min and a feed rate of 0.1-0.2 mm p.r.

Excessive feed rate will cause brittle fracture of material; low feed rate at high cutting speed will lead to material overheating. Material thickness beyond 5 mm will require cooling and lubrication with acrylic compatible drilling emulsion or bore oil.

Deep-hole boring requires frequent airing of the drill in order to prevent local overheating.

When drilling thin sheets, it is advisable to fix them on a solid, flat support to avoid brittle breaks of the lower edge of the drilled hole.

Drilling of POLYCASA XT	
Clearance angle $\alpha$	3 – 8°
Twist angle $\beta$	12 – 16°
Point angle $\epsilon$	60-90°
Rake angle $\gamma$	0 – 4°
Cutting speed (m/min)	25 - 80

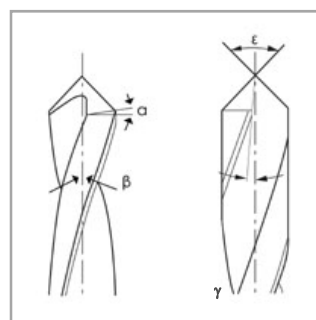

### 7.5.4 THREAD CUTTING

Internal thread cutting in POLYCASA XT sheets is feasible with commercially available taps. Tools producing threads with slightly rounded core diameters are particularly suitable. Compared to steel, the core drilling clearance should be about 0.1 mm larger. Thread cutting requires frequent chip discharge with compressed air. Only cooling lubricants compatible with acrylic should be used.

Follow-on screw fitting implies that the metal screws employed are oil film-free or protected against corrosion by means of oil compatible with acrylic. Compared to cast acrylic' extruded acrylic shows an increased breakage risk by notch effect. Fixings which are frequently removed should be provided with threaded inserts.

### 7.5.5 MILLING

Universal, profile, spindle moulding and hand milling cutters at cutting speeds up to 4500 m/min can be used for milling POLYCASA XT sheets.

Small tool diameters require the application of one or two-edged milling cutters. They offer perfect removal of chips, high cutting speed and an excellent milling pattern.

When using one-edged milling cutters, the clamping chuck must be carefully tightened to avoid component marks on the sheet.

Cooling is not always required when milling POLYCASA XT sheets with one or two-edged end mills, as they produce less heat than multi-edged end mills.

## POLYCASA XT - ACRYLIC SHEETS

### 7.5.6 LASER CUTTING

POLYCASA XT sheets are easy to cut with a CO<sub>2</sub>- laser. Brilliant edges of cut can be achieved but this can vary depending on type, thickness and surface treatment. The laser operating efficiency should amount to 300 – 1000W. Inert gas rinsing and extraction of monomer vapours must be ensured.

Preliminary tests are essential in order to determine exact positioning in each case.

Inclined edges of cut, not being square to the sheet surface, will result from increasing material thicknesses. Neodym-YAG lasers permit excellent engraving of coloured POLYCASA XT sheets.

High thermal load in the cut edge zone generates stresses liable to produce stress cracking when being in contact with corrosive substances (during bonding process for example).

Tempering of components will prevent cracking by stress relief at a temperature of 80°C (see chapter 7.7.3 „Tempering“).

During laser cutting, the cut edges of POLYCASA XT high-impact grades do not show the same brilliancy as POLYCASA XT grades; the edges of cut can be somewhat “tacky”.

### 7.5.7 WATER JET CUTTING

Similarly to laser cutting, the possible cutting speed depends on both thicknesses of the material to be cut and desired cutting quality.

Unlike laser cutting, the cut edges look “sand-blasted” as a result of water jet cutting. No thermal stresses occur in the material when using water jet cutting technique.

The water used for cutting POLYCASA XT sheets contains abrasive additives.

Good results are achieved with a cutting speed of 1500 - 2000 mm/min and a material thickness of 4 mm.

A feed rate of 400 - 800 mm/min and a material thickness of 10 mm will produce good results.

### 7.5.8 POLISHING

Prior to hand-operated polishing, the sheet must be ground. Hand-operated grinding requires the use of 80-600-grit abrasive paper as well as several grinding work cycles from rough-grind up to finish-grind. Mechanical grinding should be done with belt grinders and a belt speed of 5 - 10 m/s. High surface temperatures can be avoided by lightly pressing on the work piece. Polishing is made with buffing or fleece polishing wheels, polishing felts and adequate polishing wax.

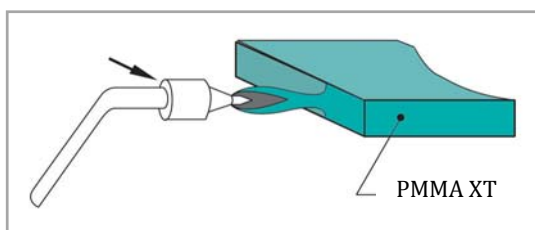

Polish-milling with diamond-tipped tools is another process option. The surface quality is such that no further treatment is required. Polish-milling - in one single work cycle without rough-grinding - will produce excellent finish. No internal stress occurrence; tempering which is essential to other procedures, becomes redundant.

Flame-polishing of POLYCASA XT does not require additional grinding work cycles. The edges to be polished must be sawdust free and oil free.

Sawing and milling lines may still be visible - even after polishing. Improved surface finish is achieved by treating the sawn edge with an iron scraper prior to flame polishing.

Due to pigments, coloured material often shows matt edges.

Flame polishing is not recommended for sheets with a thickness of more than 10 mm because of local overheating and resultant stresses.

If followed by contact with corrosive substances such as solvents, glues or inappropriate cleaning agents, tempering will be essential.

## POLYCASA XT - ACRYLIC SHEETS

### 7.6 JOINTING

#### 7.6.1 BONDING

The joint faces must be cleaned prior to bonding. Use warm water containing some washing-up liquid, if necessary; dry with an absorbent, lint free fabric (e.g. glove material). Highly greasy or oily surfaces can be washed with cleansing petrol.

The components to be bonded should be tempered to release stresses prior to bonding in order to avoid potential stress cracking (crazing) due to the reaction with the solvent glue; this applies especially to components having been machined by metal-cutting tools or cut by laser.

**Solvent adhesives** are particularly suitable for small and plane bonding surfaces.

As the solid content of such glues is low, they have no joint filling capability. When bonding the sawn edge, smoothing the surface to be bonded using sharp edge scraper can reduce possible bubble formation. Immersion technique implies that the edge to be glued is dipped into solvent or solvent adhesive, which is poured approx. 1 mm high onto a glass or PE sheet; the parts are afterwards firmly jointed.

Capillary method offers a simple technique for jointing and fixing of the parts. Solvent adhesive/solvent, is applied onto the bonding surface by means of a PE-vial and is soaked into the glued seam due to the capillary effect; a few seconds later, the joint should be firmly pressed together to set the joint.

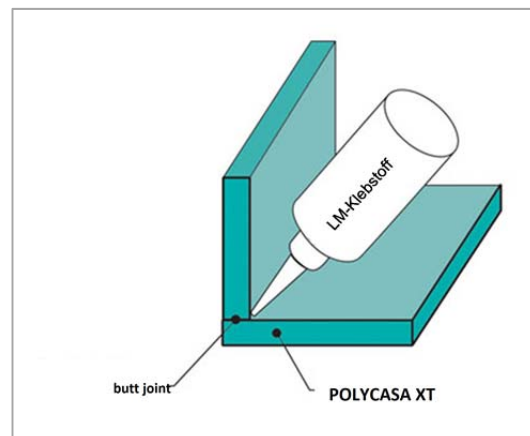

**Polymerisation adhesives** are also suitable for large and uneven bonding surfaces. Planar bonding is possible.

The pasted seam must be prepared by chamfering; this does not apply to butt joint bonding. The adjacent sheet area must be masked with an adhesive compatible tape. The adhesive must be mixed as prescribed by the adhesive supplier. Removal of bubbles in vacuum is possible.

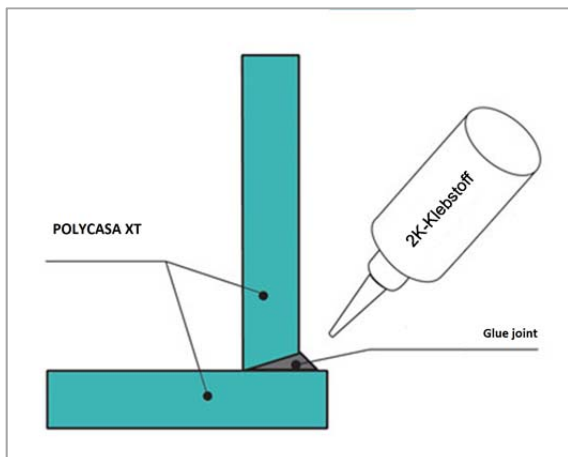

The adhesive must be applied bubble-free by means of a PE-vial or a disposable syringe. Excess adhesive must be provided, as the polymerisation adhesive exhibits volume shrinkage during curing.

**Silicones** are often used to seal glazing. For this purpose, only silicones compatible with acrylic must be employed.

Silicone sealants as found in DIY centres, give off substances during curing which will result in stress cracks of the glued components.

Our technical service department will provide you with information on appropriate products.



## POLYCASA XT - ACRYLIC SHEETS

### 7.6.2 WELDING

Hot-gas welding is the most frequent welding technique used for POLYCASA XT sheets.

The strong heating of the weld zone and the cooling effect from the adjacent sheet surface areas result in tensile stress formation after cooling which must be relieved by tempering, as they will lead to stress cracking when in contact with solvent and adhesives. Quadratic sheet strips of POLYCASA XT, round rods or sheet strips of PVC rigid will serve as filler material.

Gas-welding temperature should amount to 280 - 350°C.

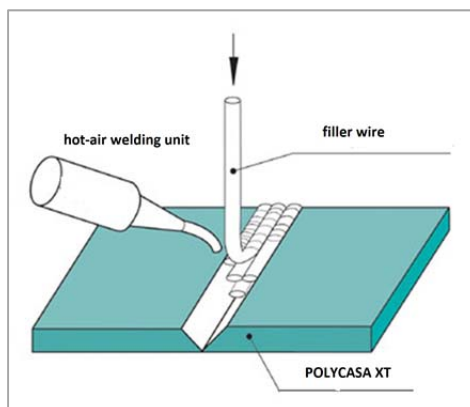

#### More technical data:

Welding pressure/3 mm rod:

20 Newton

Welding speed:

150 to 250 mm/min

Distance from nozzle to

Welded joint:

10 to 20 mm

Air mass:

about 25 l/min

The die diameter should be more or less the same as the filler rod diameter.

## POLYCASA XT - ACRYLIC SHEETS

### 7.7 FORMING

**NOTE:**

Prior to thermoforming and hot bending of POLYCASA XT, it is recommended to remove the protective foil. As the foil behaviour depends on material processing conditions such as draw ratio and required temperatures, simple mouldings can be formed without removing the foil. Preliminary tests are essential to determine the foil behaviour in each individual case.

#### 7.7.1 HOT BENDING

Hot bending technique means extended heating of the sheets followed by bending and fixing until the sheets have cooled down.

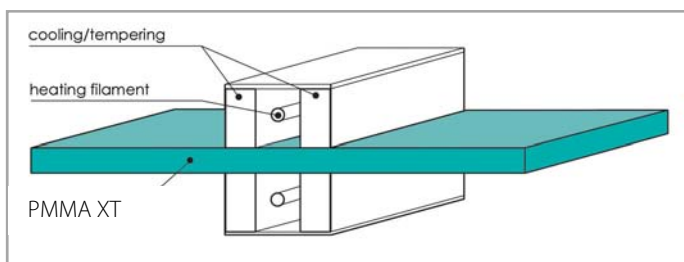

Extended heating is carried out by filaments or heating rods. The heating time depends on the equipment employed and will rise considerably according to increased material thickness.

The bend radius must be twice as big as the material thickness in order to prevent wrinkles and high stresses.

Visual appearance of the inner bend can be improved by using the biggest possible bend radii and thin sheets.

The heating width should be at least 3 to 5 times larger than the sheet thickness. A heating width of 3 times the sheet thickness is adequate for small bend radii.

Too small heating zones will lead to excessive elongation and straining in the bend area and - as a result - to optical impairment.

Large heating widths will enable production of big bend radii.

Due to the memory effect, the exact angle specifications must be determined by preliminary tests.

#### 7.7.2 THERMOFORMING

Thermoforming technique means that, at increased temperatures, thermoplastic semi-finished products are shaped into three-dimensional plastics mouldings. The sheet material is heated up to the thermo-elastic temperature range and shaped by suitable moulds

Vacuum forming requires a forming temperature of 160 - 190°C. Good results are realized with a mould temperature of 85°C.

Venting bores in vacuum moulds should have a diameter of  $\varnothing$  0.8 mm; too large diameters will cause marks.

Processing shrinkage of POLYCASA XT will amount to 0.5 - 0.8% depending on the procedures employed.

Lower forming temperatures will suffice to form high-impact POLYCASA XT grades.

A forming temperature of 140 - 170°C is sufficient when forming POLYCASA XT 610. The forming temperatures necessary to form high-impact grades XT620 and XT630 are between those required for POLYCASA XT610 and POLYCASA XT.

At a temperature beyond 80°C, POLYCASA XT610/620/630 grades will show a distinct turbidity that will recede during cooling process.

Should bubbles appear when heating POLYCASA XT, this is due to moisture absorption during storage; in that case, the sheets must be pre-dried before forming.

In general, overnight pre-drying at 80°C will suffice (see chapter 7.3.2. "Drying").

## POLYCASA XT - ACRYLIC SHEETS

### Positive and negative forming

Dependent on whether the inside or the exterior of the mouldings contact the tool, the techniques are called “positive” or “negative” forming. Positive forming means that the heated semi-finished product is pulled over the mould. This is also known as “male” forming. In doing so, some surface areas of the heated semi-finished products may excessively cool down, so that complete drawing is not feasible and “thick spots” will occur. Some typical problems during positive forming, such as wrinkle or web formation (2) and shock marks, can be solved by adequate pneumatic stretching prior to final “pull down. High tool temperatures and high tool speed can also cause shock marks.

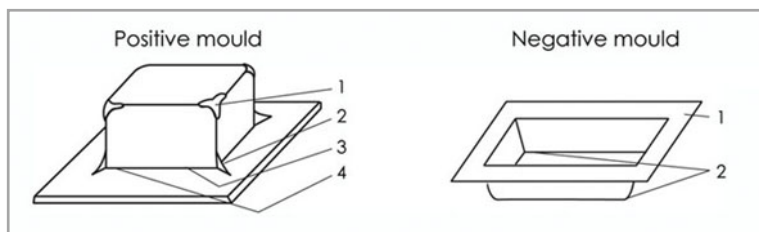

Negative forming means that the semi-finished sheet is drawn into the mould cavity. This is sometimes called “female” forming. Thin corner areas (2), which may appear during negative forming of sharp-edged components, can be reduced by mechanical top die stretching.

### Procedure variant

Dome-shaped mouldings can be thermoformed without a mould. This method produces mouldings of good surface quality showing no optical defects. The dome form is determined by the clamping frame’s shape and the dome height by the blown air pressure.

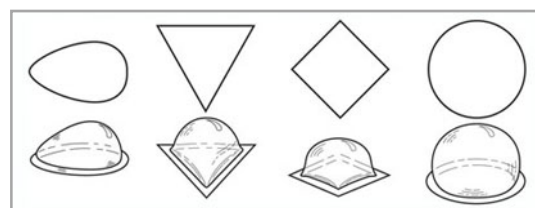

### 7.7.3 TEMPERING

POLYCASA XT is able to take up rather high tensile stresses, but only if corrosive substances do not simultaneously act upon the materials.

Tensile stresses are induced by machining, laser-cutting, thermoforming, varying heating and external stresses, for instance. Tensile stresses expand the material structure thus reducing the resistance to environmental conditions. The effect of printing ink solvents, monomer vapours, sealing and foil plasticizers as well as inappropriate cleaning agents may result in crack formation.

Crack formation will be excluded by stress free components. Therefore, generation of tensile stresses and contact with corrosive substances must be avoided.

As accidental contact with corrosives cannot be ruled out, tensile stresses must be avoided. Stress relief tempering of the parts can achieve reduction of internal stresses. External stresses must be excluded by using adequate fastening systems.

Tempering of POLYCASA XT should take place in heating cabinets with air circulation, at a temperature of 70 - 80°C.

It is recommended to temper without protection film.

<b>Material thickness (mm)</b>	1,5	2	3	4	5	6	8	10	12	15	18	20	25
<b>Tempering duration (h)</b>	2	2	2	2	2	3	3	4	4	5	6	7	8

POLYCASA XT sheets must be cooled down slowly to avoid repeated induction of the internal stress or moisture due to cooling down too fast after annealing. The maximum cooling speed after annealing has to be less than 15 °C per hour.

The maximum oven temperature from which the material may be removed is 60°C.

## POLYCASA XT - ACRYLIC SHEETS

### 7.8 GLAZING

POLYCASA XT expands under heat and moisture absorption and contracts in cold and dry weather. The linear change solely due to the change in temperature can be determined by calculating the coefficient of thermal expansion.

POLYCASA XT shows a coefficient of thermal expansion of 0.07 mm/m•°C.

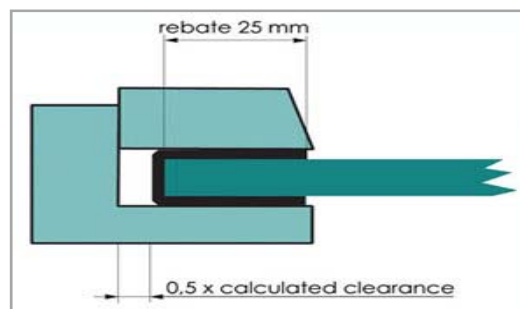

The linear change must be allowed during the sheet's storage time. The maximum expected value of linear deformation depends on the temperature used when mounting the sheets.

An adequate free space of 5 mm/m should be kept with POLYCASA XT (guide value).

The rebate should be approx. 20 – 25 mm deep.

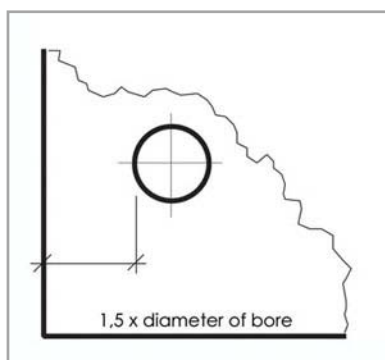

To achieve impermeability of glazing to rain water, only sealing agents shall be used which are compatible with extruded acrylic sheet Construction and sealing material must allow the movement of sheet inside the profiles due to dimensional changes of sheet. Profiled EPDM joints, preferably in white, have proven to be successful in heat loss avoidance. In most cases, profiled joints of non-rigid PVC and PUR foam are incompatible, due to the migration of plasticizers.

The drilled holes must be adequately dimensioned when fixing to specific points, in order to also allow for a sheet length clearance of 0.07 mm/m•°C.

In that case, sheet length is deemed to be the greatest existing distance between two holes. To avoid material breaking at the sheet edge, a distance of 1.5 times the diameter of hole must be left.

#### 7.8.1 VERTICAL AND HORIZONTAL GLAZING

The required material thickness for 4-side clamped glazing can specify according to the following table. Material thicknesses needed for glazing primarily depend on the sheet size.

A surface load of 750 N/m<sup>2</sup> is taken as basis for the recommended material thickness in mm.

		POLYCASA XT (material thickness)									
		Length (m)									
		0.5	1.0	1.5	2.0	2.5	3.0	3.5	4.0	4.5	5.0
Width (m)	0.5	3	4	4	4	4	4	4	4	4	4
	1.0	4	6	8	8	8	8	8	8	8	8
	1.5	4	8	10	10	12	12	12	12	12	12
	2.0	4	8	10	12	15	15	-	-	-	-

Information on deviating surface loads or sizes is available from our application technology department upon request.

## POLYCASA XT - ACRYLIC SHEETS

### 7.8.2 BARREL VAULTS

POLYCASA XT is suitable for cold bending technique. This method facilitates the application of thinner material gauges compared to plane roofing, as an increased self-rigidity of the sheet is achieved due to the change in geometry.

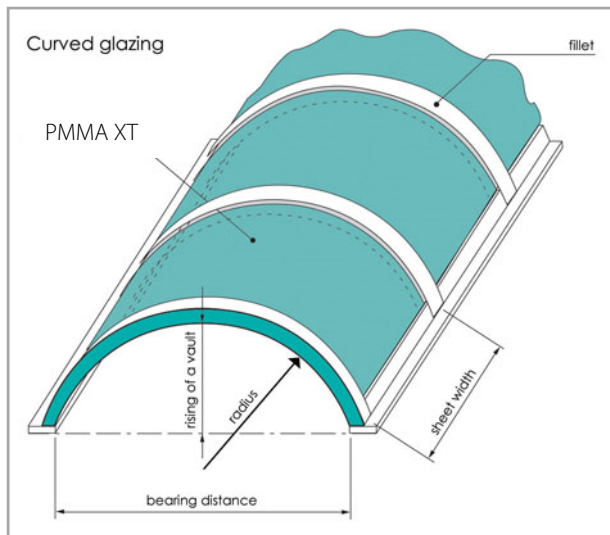

to plane roofing, as an increased self-rigidity of the sheet is achieved due to the change in geometry.

In order to exclude material damage caused by tension stress and environmental influences, the min. bending radius must not be less than 330 x the sheet thickness. As far as fixing and sealing are concerned, only materials not having corrosive (crazing) effect on POLYCASA XT should be used.

Recommended material thicknesses in mm at a given surface load of 750 N/m<sup>2</sup> can be obtained from the following table.

Information on recommended material thicknesses in case of various surface loads is available from our Technical Service Department upon request.

POLYCASA XT					
	Radius r (mm)			Fixing span (mm)	
	500	750	1000	1250	1500
1000	3	3	3	3	
1500	3	3	4	4	4
2000	3	4	4	5	5
2500	4	4	5	5	6
3000	4	5	5	6	6
3500	4	5	6	6	8
4000	5	5	6	8	8
4500	5	6	8	8	8
5000	5	6	8	8	8

### 7.8.3 THERMAL INSULATION

POLYCASA XT sheets when used for glazing represent considerable energy cost savings as they prevent excessive heat loss in winter and heat intrusion in summer. The heat loss factor of POLYCASA XT normally referred to as K-value is significantly lower than for glass of the same thickness. The K-value is the parameter which identifies the heat loss of a building with glazed walls.

**Definition:** The K-value (U-value) identifies the heat loss in watt per m<sup>2</sup> wall surface and per °C difference in ambient temperature of premises separated by the sheet.

The K-value depends on the glazing assembly. Examples of the thermal insulation power of POLYCASA XT in single, double and triple glazing systems are indicated below. Compared to glass, they show significant advantages as to insulating effect and weight reduction.

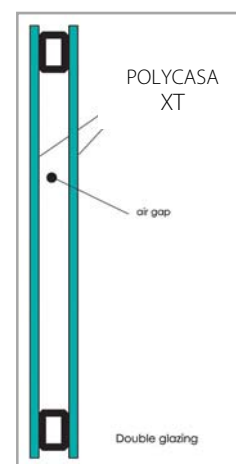

## POLYCASA XT - ACRYLIC SHEETS

Installation		POLYCASA XT			Window glass	
Sheet thickness (mm)	Air gap (mm)	Composite strength (mm)	K-value (W/m <sup>2</sup> *K)	Weight (kg/m <sup>2</sup> )	K-value (W/m <sup>2</sup> *K)	Weight (kg/m <sup>2</sup> )
<b>Single glazing</b>						
2	-	2	5,54	2,38	5,83	4,96
3	-	3	5,39	3,57	5,80	7,44
4	-	4	5,24	4,76	5,77	9,92
5	-	5	5,10	5,95	5,74	12,40
6	-	6	4,96	7,14	5,71	14,88
8	-	8	4,72	9,52	5,66	19,84
10	-	10	4,49	11,90	5,60	24,80
<b>Double glazing</b>						
2	5	9	3,34		3,55	
2	10	14	2,94	4,76	3,10	9,92
2	15	19	2,77		2,91	
3	5	11	3,23		3,53	
3	10	16	2,85	7,14	3,09	14,88
3	15	21	2,69		2,90	
4	5	13	3,12		3,50	
4	10	18	2,77	9,52	3,07	19,84
4	15	23	2,62		2,88	
5	5	15	3,02		3,48	
5	10	20	2,69	11,90	3,05	24,80
5	15	25	2,55		2,87	
<b>Triple glazing</b>						
2	2 x 5	16	2,39		2,55	
2	2 x 10	26	2,00	7,14	2,11	14,88
2	2 x 15	36	1,84		1,94	
3	2 x 5	19	2,30		2,53	
3	2 x 10	29	1,94	10,71	2,10	22,32
3	2 x 15	39	1,79		1,93	
4	2 x 5	22	2,22		2,52	
4	2 x 10	32	1,88	14,28	2,09	29,76
4	2 x 15	42	1,74		1,92	
5	2 x 5	25	2,15		2,50	
5	2 x 10	35	1,83	17,85	2,08	37,20
5	2 x 15	45	1,70		1,91	

Information on further specific glazing systems can be obtained from our Technical Service Department upon request.

### 8.0 CONCLUDING REMARKS

For more details on further processing methods, please contact our technical customer service.

#### NOTE:

Our technical recommendations are without legal obligation.

The information given in this brochure is based on our knowledge and experience to date. It does not release the user from the obligation of carrying out their own tests and trials, in view of the many factors that may affect processing and application; neither do they imply any legally binding assurance of certain properties or of suitability for a specific purpose.

It is the responsibility of those to whom we supply our products to ensure that any proprietary rights and existing laws and legislation are observed.

Technical data of our products are typical ones; the actually measured values are subject to production variations.